

OTTOSTUMM
distinctive steel window systems

METALFORM™

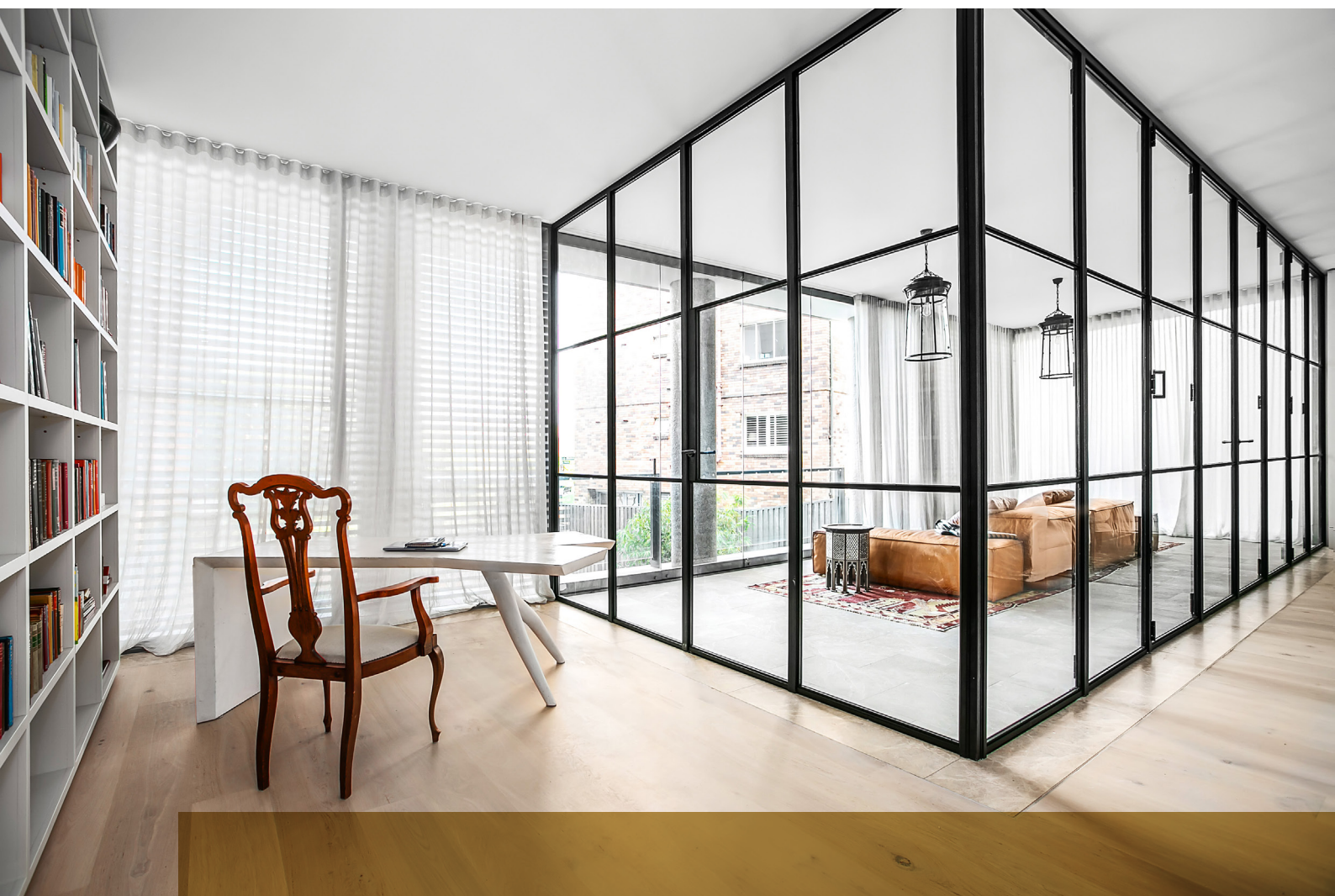

FerroFinestra®
W20 Profile

OTTOSTUMM
distinctive steel window systems

METALFORM™



FerroFinestra®
W20 Profile

FerroFinestra®
W20 Profile

The original steel window profiles of the 30's.

With the FerroFinestra® systems, OTTOSTUMM gives continuity to that style that, with its elegant and minimalistic lines, delighted European architecture. Ideal in restoration and fascinating in new buildings, steel window profiles allow creating wide openings with slender sightlines. We re-propose systems like the popular W20 or the more contemporary W40, which accompanied modern architecture through the twentieth century. Solid hot rolled steel profiles that confer extraordinary strength to windows, adorned with countless accessories recreated starting from the original designs of that epoch. Profiles able to accommodate as well low emissivity double-glazing up to 27mm. Windows and doors made from solid steel profiles, boasting high longevity thanks to heavy-duty corrosion protections like hot dip galvanizing, thermal zinc spraying or cataphoresis coating. Any kind of inward or outward openings: single and double-vents, side-hung, double-vent (French style), bottom-hung, top-hung or projected top-hung, horizontally and vertically pivoted windows, as well as large sliding and folding doors.

Hot rolled steel

This series has its origins in the “Universal Range”, which was introduced for the first time in 1912 by the British company “The Crittall Manufacturing Co. Ltd.”.

The Universal range consisted of three different ranges of hot rolled profiles, identical in geometry and types, but different in their depth, that classified them into large, medium and small. Depending on the dimensions of the window, the most appropriate series was selected to match the static requirements. These three ranges were able to cover any type of window and opening. In combination with special T-profiles, used as mullions and transoms, for the first time it was also possible to realize curtain walls of any size. The currently available range was revised in 1964 and re-coded as “W20”. The three separate ranges were condensed into one medium range, which consisted of 20 hot rolled profiles able to cover the functions of modern windows and grant the original design and proportions for those to be replaced in historic buildings. Even today, after more than 100 years, this timeless series is still chosen for a great number of restoration projects worldwide.



Features of W20

1. Solid hot rolled steel profiles
2. Classic “stepped leg” design
3. Material thickness up to 5 mm
4. Self-adhesive non-shrinking gaskets
5. Accommodates low emissivity double-glazing up to 21 mm
6. Choice of different glazing beads
7. Fixed glazing, single-sash and double-sash, side-hung and bottom-hung windows opening inwards and outwards, top-hung, vertical and horizontal pivoting windows, window and doors opening inwards and outwards

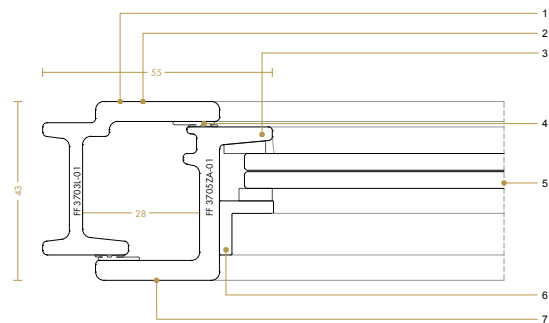

FerroFinestra W20

profile range - bar lenght 5800 mm

-01 Hot rolled steel -14 Laser welded and sand blasted steel

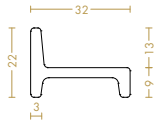

FF 3203LF-01

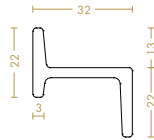

FF 3203ZF-01

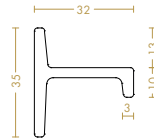

FF 3203TF-01

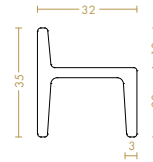

FF 3203HF-01

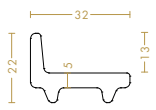

FF 3205LC-01

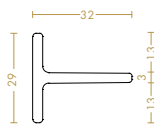

FF 3203TN-01

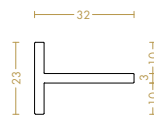

FF 3203TR-14

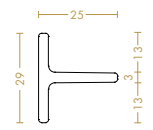

FF 2503TR-01

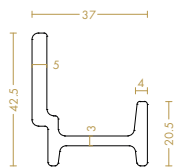

FF 3703L-01

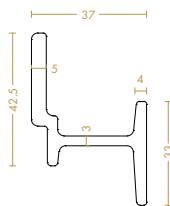

FF 3703Z-01

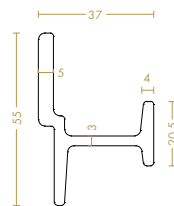

FF 3703T-01

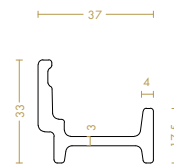

FF 3703LS-01

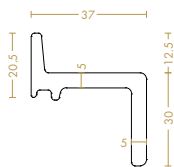

FF 3705ZA-01

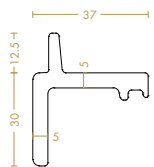

FF 3705TA-01

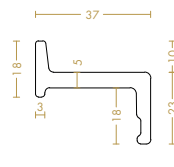

FF 3705ZS-01

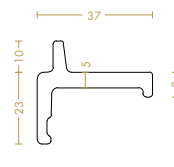

FF 3705TS-01

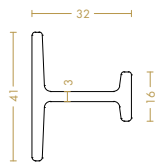

FF 3203TD-01

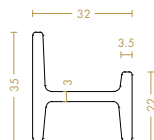

FF 3203H-01

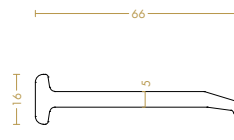

FF 6605SO-01

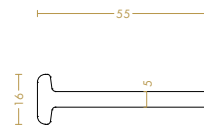

FF 5505SV-01

snap-on glazing beads - bar length 5800 mm

clips

-00 Aluminium -03 Stainless steel AISI 304 2B

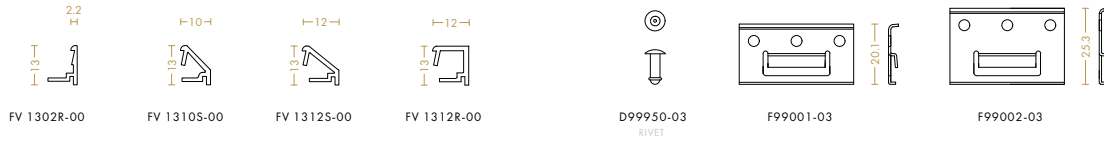

screw-on glazing beads - bar length 5800 mm

fixing screw

-01 Hot rolled steel -03 Stainless steel AISI 304 2B



false muntins - bar length 5800 mm

double-side adhesive

-01 Hot rolled steel -02 Galvanized steel -14 Laser welded and sand blasted steel -74 Adhesive strip

* minimum quantity required

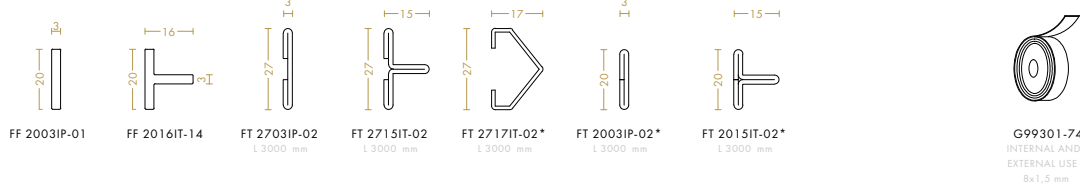

rebate gaskets

glass - external gaskets

-60 EPDM black -61 Neoprene -62 PVC



glass - internal gaskets

-60 EPDM black -61 Neoprene

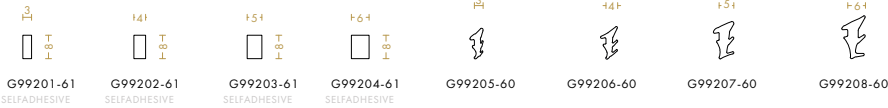

weather bars

-00 Aluminium -02 Galvanized steel -06 Satin stainless steel AISI 316L

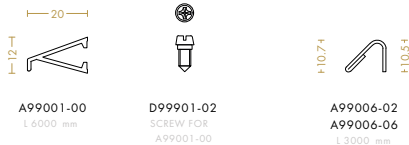

automatic drop seal

sideward cover cap for drop-down seal

-35 Black -41 Grey RAL 7035 -62 PVC

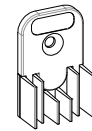

G99511-35 BLACK
G99511-41 GREY RAL7035

FerroFinestra W20

examples - open in

SECTION 1

EXTERNAL

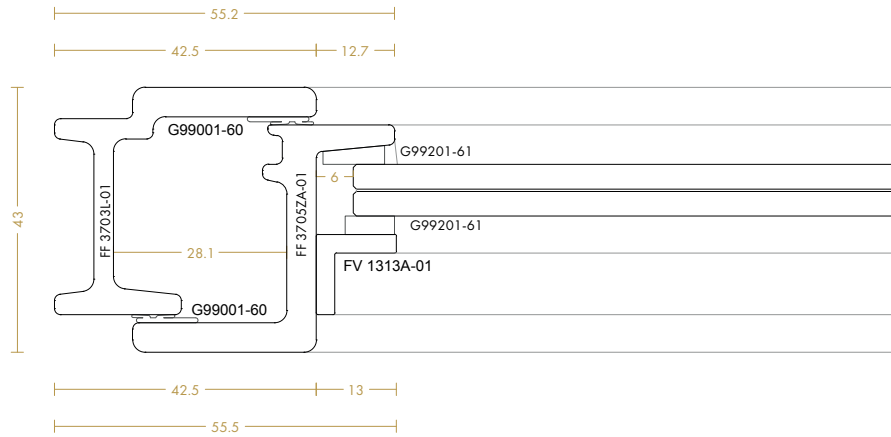

SECTION 2

EXTERNAL

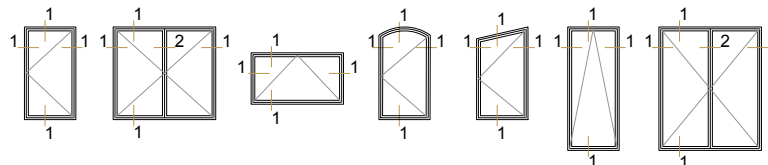
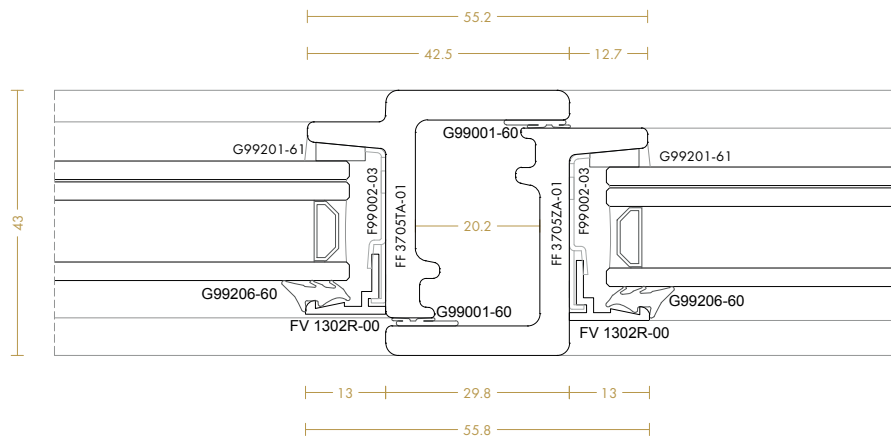

examples - open out

SECTION 3

EXTERNAL

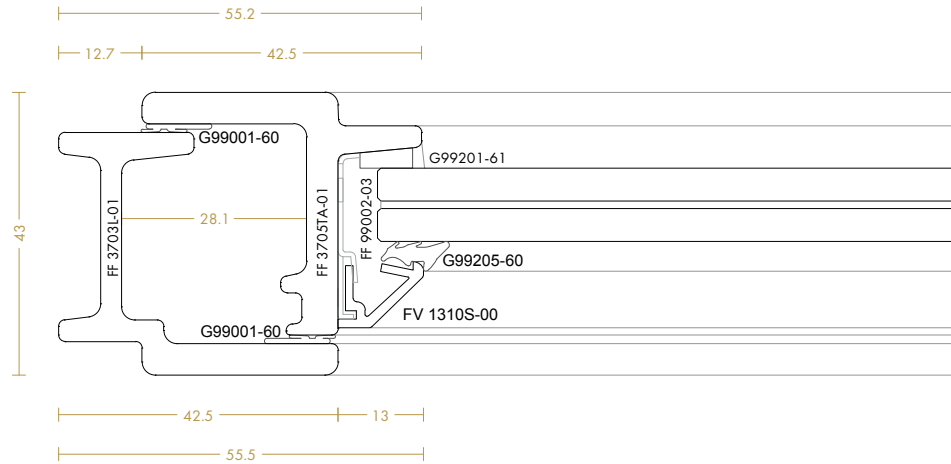

SECTION 4

EXTERNAL

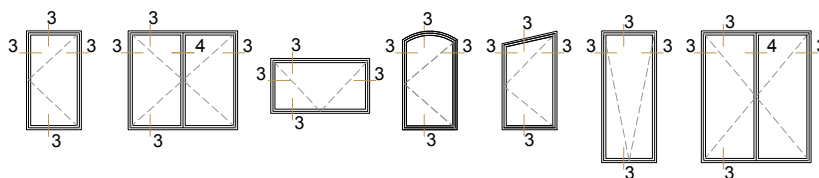
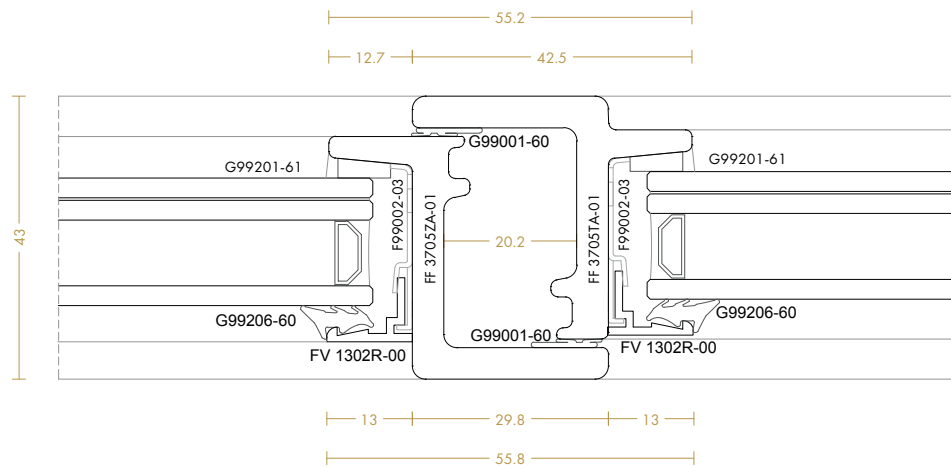

FerroFinestra W20

examples - fixed

SECTION 5

EXTERNAL

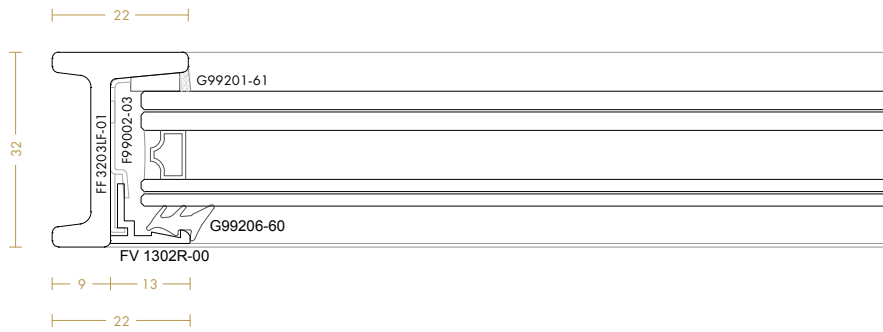

SECTION 6

EXTERNAL

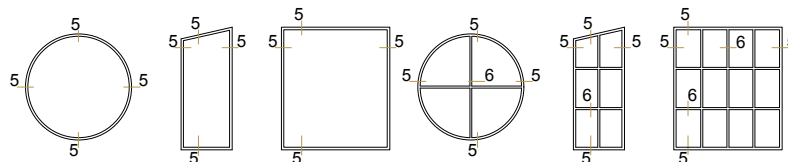
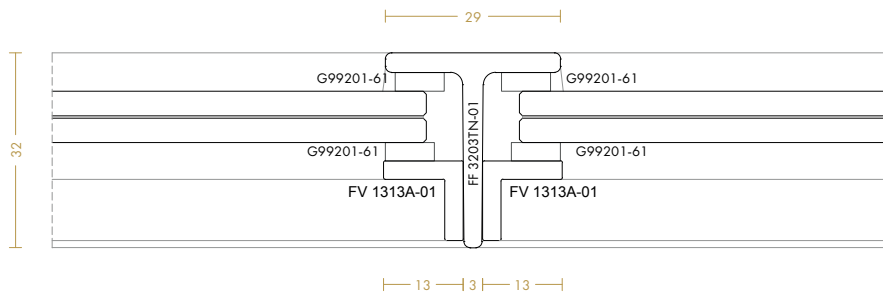

Here to talk

UNITED KINGDOM

Orion House
Barnhill
Stamford
PE9 2AE

sales@metalform.uk
projects@metalform.uk

+44 (0) 1780 437995

facebook.com/metalformuk
instagram.com/metalform_europe
linkedin.com/company/metalform-group
pin.it/61AyQIm

NORWAY

Metalform AS

1950 Rømskog, Østkroken 106
Tel: 40 16 24 46
Org. nr: 999003265 MVA

Metalform Bergen:
Storevarden 54, 5350 Brattholmen
Tel: 918 72 226

Avdelingskontor:
Kongsveien 98, 1177 Oslo
Tel: 401 62 446

post@metalform.no
salg@metalform.no

SWEDEN

Metalform AS
Østkroken 106
Org.nr:999003265
1950 Rømskog
Norge

info@metalform.se

facebook.com/Metalformeurope/
instagram.com/metalform_europe?igshid=68mngyz6w9mr
pin.it/61AyQIm

metalform.uk
metalform.no
metalform.se
metalformgroup.com